

目錄

	原子印章	1-12
	GX系列	13
	尺寸表	14
<hr/>		
	膠印	15
<hr/>		
	回墨印	
	PRINTY	16-23
	PROFESSIONAL	24-27
<hr/>		
	CNC雕刻	28-29
<hr/>		
	綠盒套裝	30
<hr/>		
	現貨印	31
<hr/>		
	字款	32-33
<hr/>		



Pre-ink Stamp 原子印

POC1



這份 文口供，共 頁紙。
 每一頁均由本人簽署，並已由本人
 閱讀過/由 用 文
 向本人覆讀。本人獲告知本人可隨
 意作任何修改、更正或增補。

顏色



規格

Max size: 60mm x 24mm

K1



會計項目 已收貨款
 繼續努力 請保持整潔
 欠交回條

顏色



規格

Max size: 24mm x 7mm

SS, SS1



顏色



規格

Max size:
SS: 41mm x 11mm
SS1: 28mm x 9mm

K1A



香港特別行政區政府

香港中文大學圖書館

The Chinese University of Hong Kong

顏色



規格

Max size: 43mm x 7mm

K2



🏠: 將軍澳廣場1樓X舖 ☎: 8888 9999

香港特別行政區政府

顏色



規格

Max size: 63mm x 7mm



Pre-ink Stamp 原子印

SQ1



爛邊楷書 爛邊隸書 爛邊篆書

顏色



規格

Max size: 12mm x 12mm

SQ2



圓角楷書 圓角行書 圓角古篆

顏色



規格

Max size: 16mm x 16mm

SQ3

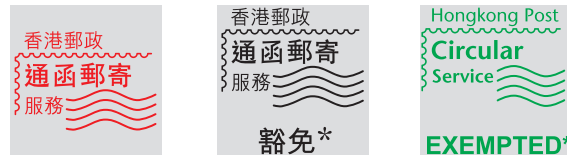

顏色



規格

Max size: 20mm x 20mm

SQ4

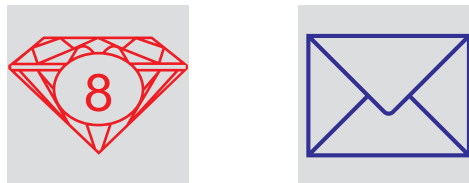

顏色



規格

Max size: 24mm x 24mm

SQ5



顏色



規格

Max size: 30mm x 30mm

SQ6

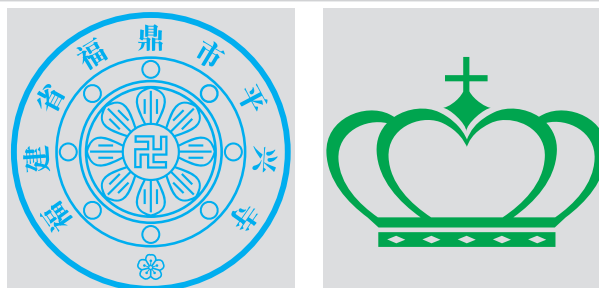

顏色



規格

Max size: 38mm x 38mm



Pre-ink Stamp 原子印

R1

		<p>顏色</p> <p>● 黑 ● 淺藍 ● 紅 ● 綠 ● 紫</p> <p>規格</p> <p>Max size: Ø:15mm</p>
--	--	---

R2

		<p>顏色</p> <p>● 黑 ● 淺藍 ● 紅 ● 綠 ● 紫</p> <p>規格</p> <p>Max size: Ø:21mm</p>
--	--	---

R3

		<p>顏色</p> <p>● 黑 ● 淺藍 ● 紅 ● 綠 ● 紫</p> <p>規格</p> <p>Max size: Ø:33mm</p>
--	--	---

R4/R5/R6

		<p>顏色</p> <p>● 黑 ● 淺藍 ● 紅 ● 綠 ● 紫</p> <p>規格</p> <p>Max size: R4-Ø:38mm R5-Ø:42mm R6-Ø:48mm</p>
--	--	--

OV2

		<p>顏色</p> <p>● 黑 ● 淺藍 ● 紅 ● 綠 ● 紫</p> <p>規格</p> <p>Max size: 36mm X 24mm</p>
--	--	--

OV

		<p>顏色</p> <p>● 黑 ● 淺藍 ● 紅 ● 綠 ● 紫</p> <p>規格</p> <p>Max size: 43mm X 29mm</p>
--	--	--



Pre-ink Stamp 原子印

G01



Nancy HO Lan-sang
Assistant Chief Commissioner
(Public Relations)

Cheung Hing Construction Co. Ltd.
Contract No. TCY 041
W.O./M.W.O. Administration Purpose

顏色



規格

Max size: 38mm x 11mm

G02



福滿臨珠寶(柴灣)金行
電話：9999-8888

HSBC 098-551989

顏色



規格

Max size: 53mm x 11mm

G03



聯絡人資料此合約才能生效
租客需提供入息證明及

塘尾道官立小學中央圖書館

顏色



規格

Max size: 68mm x 11mm

G04



雙方同意從價印花稅由買方支付，額外印花稅(如有)則由賣方於完成交易前支付。
Both Parties agree that ad valorem property transaction stamp duty shall be paid by the Purchaser and Special Stamp Duty (if any) shall be paid by the Vendor before completion.

由2012年10月27日起，若買方購買物業後，
3年內轉售政府將會加收額外物業印花稅

顏色



規格

Max size: 81mm x 11mm

G05



有關此合約一切責任得租客_____，
同意由_____ ID _____ 代簽及負責。

顏色



規格

Max size: 101mm x 11mm

G06



馮芝雲姑娘
助理社會工作主任
直線：2345 6789



顏色



規格

Max size: 41mm x 15mm



Pre-ink Stamp 原子印

G07



憑單取貨

顏色



規格

Max size: 53mm x 15mm

G08

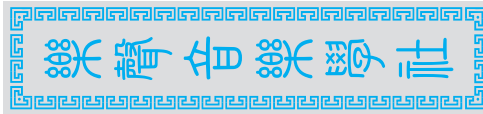

顏色



規格

Max size: 65mm x 15mm

G09



E-Call Reason	EC1 停止運作	EC4 困人
急電原因	EC2 機門失效	EC5 跌倒/受傷
▼	EC3 樓層不平	EC6 其它(請列明)

顏色



規格

Max size: 76mm x 15mm

G10



顏色



規格

Max size: 89mm x 15mm

G11



香港郵政
通函郵寄服務

原裝正貨

顏色



規格

Max size: 41mm x 20mm

G12



招商局貨櫃
中流附加費未付

顏色



規格

Max size: 53mm x 20mm



Pre-ink Stamp 原子印

G13



本人核證所有資料無誤，並證明：
 (i) 沒有獲發收據；
 (ii) 確實已在_____支付有關開支；
 (iii) 有關開支不曾獲發還款項

顏色



規格

Max size: 65mm x 20mm

G14



環球貨運有限公司
 香港北角蜆殼街9-23號
 秀明中心26E-H室
 TEL: 8888 8888

顏色



規格

Max size: 76mm x 20mm

G15



預計保養（抹油）工時 ANTICIPATED MAINTENANCE DURATION			
每年/季不少於	_____	小時	hours
Annually/Quarterly not less than	_____	小時	hours
預計每次需時	_____	小時	hours
Per visit duration around	_____	至	_____
	hours	to	hours

顏色



規格

Max size: 89mm x 20mm

G16



Air Sea Worldwide Logistics Ltd.
 港捷國際貨運有限公司

進倉批准章

顏色



規格

Max size: 41mm x 25mm

G17



B 何東樓車廠重建基礎工程
 收料專用章
 請憑此單到本公司結賬
 中國海外基礎工程有限公司

顏色



規格

Max size: 53mm x 25mm

G18



For and on behalf of
 環球原子印系列
 WORLD WIDE STAMP SERIES

.....
 Authorized Signature(s)

顏色



規格

Max size: 65mm x 25mm



Pre-ink Stamp 原子印

G19



宏利
Manulife

Chan Ming Ming
陳明明

電話：(852) 1234 5678

18th Floor, Manulife Provident Funds Place,

電話：(852) 8888 8888

345 Nathan Road, Kowloon, Hong Kong.

傳真：(852) 2345 6789

九龍彌敦道三四五號宏利公積金大廈十八樓

電郵：www@manulife.com.hk

顏色



規格

Max size: 76mm x 25mm

G20



「如你不欲收取通函郵件，請在信箱上貼上『不收取通函』標貼。標貼可於全線郵政局、各區民政事務處的公眾諮詢服務中心、公共屋邨辦事處和個別私人屋苑的管理處免費索取。請注意，『不收取通函』標貼機制並不涵蓋由政府及相關機構、立法會議員、區議會議員、選舉候選人和根據《稅務條例》第88條合資格獲豁免繳稅的慈善機構所投寄的通函郵件。」

顏色



規格

Max size: 89mm x 25mm

G21/G21A



公司名稱: _____	貨物是否損毀: (箱號) _____
員工姓名: _____	接收日期: _____
員工編號: _____	接收時間: _____

顏色



規格

Max size:

G21-101mm x 25mm

G21A-126mm x 25mm

G22



	Mc Donald's	165
Date	_____	
Received	_____	
Checked	_____	
Approved	_____	
SUN TUEN MUN		

顏色



規格

Max size: 53mm x 30mm

G23



麻布茶室

憑單於12:30前結賬離座，21:30後入座惠顧，可獲八八折優惠，只限銅鑼灣本店享用（加一服務費以原價計算）生效日期以此發票起計一個月內

顏色



規格

Max size: 65mm x 30mm

G24



RECEIVED DATE	_____
GOODS RECEIPT SIGNED BY REQUESTER	_____
APPROVED BY	_____
APPROVED BY	_____

顏色



規格

Max size: 76mm x 30mm



Pre-ink Stamp 原子印

G25



上水*廣場

顏色



規格

Max size: 89mm x 30mm

G26



Post-It# Fax Note	Date	# of pages ▶
To	From	
Co./Dept.	Co.	
Phone #	Phone #	
Fax #	Fax #	

顏色



規格

Max size: 101mm x 30mm

G27



環球印章系列
WORLD WIDE STAMP SERIES

(收貨章)
來貨暫收・驗後作實

經手人：
年 月 日

顏色



規格

Max size: 53mm x 41mm

G28



Goods Received & Examined
For Payment

Engineer Staff Signature

Date _____

顏色



規格

Max size: 65mm x 41mm

G29



佛教慈濟基金會香港分會
九龍灣回收物料轉運中心
九龍灣祥業街11號九龍灣綜合回收中心主樓
電話: 23054611 傳真: 23054711
電郵: mtc.tzuchi@gmail.com
開放時間: 星期一至六 9am-5pm

顏色



規格

Max size: 76mm x 41mm



Pre-ink Stamp 原子印

G30



顏色

● 黑 ● 淺藍 ● 紅 ● 綠 ● 紫

規格

Max size: 89mm x 41mm

G31/G32



蘋果(APPLE)產品退換條款

- 豐澤10天退款保證服務不適用於蘋果(APPLE)產品。
- 客人已檢查隨機配件全齊。
- 產品於購買後如有故障、損壞或任何功能失效包括主機及配件，客戶必須直接聯絡代理商作維修及保養。
- 代理商會檢查有關貨品以確定品質情況。
- 如有須要，代理商直接與顧客安排更換或維修。
- 代理商保留最終退換之決定權。
- 銷售單據已確定，不能轉換其它型號或退款。
- 客戶到代理商接受保養時，必須出示由豐澤所發出的銷售發票。
- 代理商服務及維修熱線：_____

顏色

● 黑 ● 淺藍 ● 紅 ● 綠 ● 紫

規格

Max size:
G31-101mm x 41mm
G32-126mm x 41mm

流動電話號碼可攜服務 Mobile Number Portability Service

須知 Terms

如客戶 (1)在任何時間主動要求停止此項可攜服務申請或 (2)違反其服務條款與細則而引致不能使用此項服務，客戶上台時所繳付的一切費用 (或港幣\$150，以較高之金額為準)，將不予退還，以作取消此項可攜服務申請之費用。

When the customer (1) initiates to cancel the Application at any time for whatever reasons; or (2) breaches any Terms and Conditions in the Application Form which leads to the unsuccessful porting, all the initial payments paid by the customer (or HK\$150, whichever is higher) shall not be refunded as the cancellation charges to cancel the Application.

G33

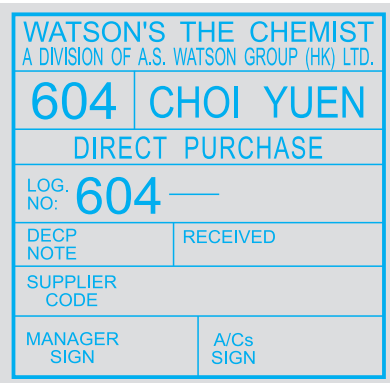

顏色

● 黑 ● 淺藍 ● 紅 ● 綠 ● 紫

規格

Max size: 53mm x 51mm



Pre-ink Stamp 原子印

G34



Routine	Initials	Date
Requested By		
Recommended By		
Last order on		
Reason for request:		
PO/PAR Checked		
Goods/Services Re'd		
Certified Correct		
Approval		
Verified & Entered (AC)		
Reviewed (AC)		
Approved (AC)		

顏色



規格

Max size: 65mm x 51mm

G35



<input type="checkbox"/> 原當人贖回 Redeemed by Borrower	<input type="checkbox"/> 非原當人贖回 Redeemed by Person other than Borrower
姓名 Name	
身份証/護照編號 I.D. Card/Passport No.	
住址 Address	
簽署 Signature	

顏色



規格

Max size: 76mm x 51mm

G36



茲證明此乃正本文件之影印本 CERTIFIED TRUE COPY	
簽名 Signature	日期 Date: ___ / ___ / ___
	分行 Branch: _____
	員工編號 UID: _____

顏色



規格

Max size: 89mm x 51mm

G37



Chen Siu Ming, John 陳小明

Associate Branch Manager 助理分行經理

Insurance Agent Registration No. 保險代理登記號碼: 07176558
Registered MPF Intermediary Registration No. 強積金中介人註冊號碼: 068777

顏色



規格

Max size: 101mm x 51mm



Pre-ink Stamp 原子印

G38



收貨日期： _____

接受 拒收

其他 _____

收貨人簽署： _____
(駐廈主管或指定授權人)

AM/AO/ME/MO 簽署： _____ (若適用)

顏色



規格

Max size: 64mm x 58mm

G39



承諾日期：
Prazo de Comprometimento

顏色



規格

Max size: 83mm x 64mm

G40



NIGHTSHIFT	
SUBMISSIONS	
PRELIMS	
Q/ASSURANCE	
MINUTES	
LAB	
MEETINGS	
OTHERS	

顏色



規格

Max size: 101mm x 64mm



Pre-ink Stamp 原子印

G41/G42



報關單 CUSTOMS DECLARATION **CN 22**

(本件得由海關開拆 May be opened officially)

Pos 401G (3/05)

Postal administration

香港郵政 **HONGKONG POST**

重要 Important!

請參閱背頁說明

See instructions on the back

- 禮物 Gift 商用樣本 Commercial sample
 文件 Documents 其他 Other
- (在適當方格內劃上"✓"號)
(Tick as appropriate)

(1) 內載物品詳情及數量 Quantity and detailed description of contents	(2) 重量 Weight (公斤 kg)	(3) 價值 Value
只適用於商品 For commercial items only (4) 協制編號及 (5) 物品原產地 (如有) <i>If known, HS tariff number (4) and country of origin of goods (5)</i>	(6) 總重量 Total weight (公斤 kg)	(7) 總共價值 Total value

在下面簽署，以證明此報關單上列資料全屬正確，及此郵件並不載有任何法例或郵政規例或海關條例所禁寄的危險物品。本人的姓名及地址已載於郵件上。

I, the undersigned, whose name and address are given on the item, certify that the particulars given in this declaration are correct and that this item does not contain any dangerous article or articles prohibited by legislation or by postal or customs regulations.

(8) 日期及寄件人簽署
Date and sender's signature / /

顏色



規格

G41

Max size: 101mm x 76mm

G42

Max size: 128mm x 88mm



Pre-ink Stamp 原子印

GX43/GX44/GX45/GX46/GX47

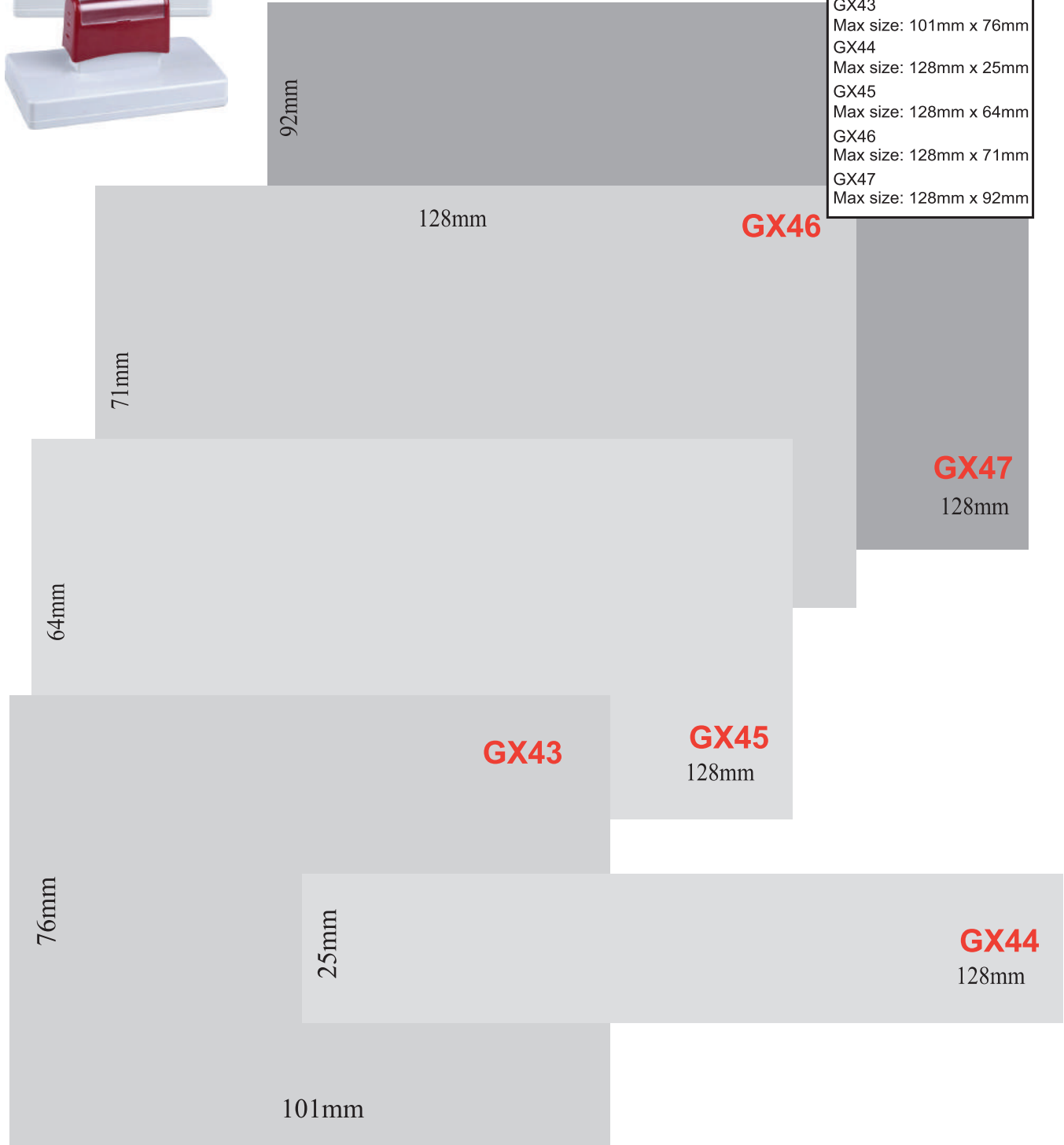

顏色	
● 黑	● 淺藍
● 紅	● 綠
● 紫	

規格	
GX43	Max size: 101mm x 76mm
GX44	Max size: 128mm x 25mm
GX45	Max size: 128mm x 64mm
GX46	Max size: 128mm x 71mm
GX47	Max size: 128mm x 92mm



原子印章殼尺寸(1:1)

注意：1.所有英文了草字体請註明大草或小草(如沒註明，一律採用大小草)。 4.落單請指定印章型號，顏色(紫,紅,黑,綠,淺藍)及數量。
 2.如印章最外圍是邊框，將以表內之實際尺寸每邊各減1mm。
 3.除P1,P2外光敏印的尺寸將以表內之實際尺寸每邊各減1mm。

15mm	G6	G7	G8	G9	G10	7mm K1 24mm	9mm SS1 28mm	11mm SS 41mm			
	41mm	53mm	65mm	76mm	89mm				7mm K1A 43mm	K2 63mm	
20mm	G11	G12	G13	G14	G15	11mm G1 38mm	G2 53mm	G3 68mm	G4 81mm	G5 101mm	
	41mm	53mm	65mm	76mm	89mm						
25mm	G16	G17	G18	G19	G20	G21	G21A				
	41mm	53mm	65mm	76mm	89mm	101mm	126mm				
30mm	G22	G23	G24	G25	G26						
	53mm	65mm	76mm	89mm	101mm						
41mm	G27	G28	G29	G30	G31	G32					
	53mm	65mm	76mm	89mm	101mm	126mm					
51mm	G33	G34	G35	G36	G37						
	53mm	65mm	76mm	89mm	101mm						
64mm						G40					
76mm						G41					
88mm						G42					
						128mm					

盒裝 **POC1**
60mm

點心印





膠印-Rubber Stamp

木排膠印

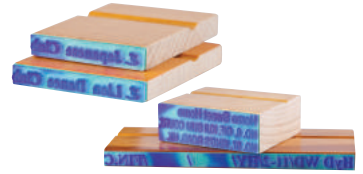

5mm	10 PA0510	25 PA0525	38 PA0538	50 PA0550	60 PA0560	70 PA0570	85 PA0585	98 PA0598	110 PA05110	120 PA05120	130 PA05130
7mm	10 PA0710	25 PA0725	38 PA0738	50 PA0750	60 PA0760	70 PA0770	85 PA0785	98 PA0798	110 PA07110	120 PA07120	130 PA07130
10mm	10 PA1010	25 PA1025	38 PA1038	50 PA1050	60 PA1060	70 PA1070	85 PA1085	98 PA1098	110 PA10110	120 PA10120	130 PA10130

膠柄膠印



8mm	14 PB0814	23 PB0823	33 PB0833	43 PB0843	53 PB0853	63 PB0863	73 PB0873	83 PB0883	93 PB0893
13mm		28 PB1328	38 PB1338	48 PB1348	58 PB1358	68 PB1368	78 PB1378	88 PB1388	98 PB1398
18mm	18 PB1818	33 PB1833	43 PB1843	53 PB1853	63 PB1863	73 PB1873	83 PB1883	93 PB1893	101 PB18101
23mm		38 PB2338	48 PB2348	58 PB2358	68 PB2368	78 PB2378	88 PB2388	98 PB2398	
28mm		28 PB2828	43 PB2843	53 PB2853	63 PB2863	73 PB2873	83 PB2883	93 PB2893	
33mm		38 PB3338	48 PB3348	53 PB3358	63 PB3368	73 PB3378	83 PB3388	93 PB3398	108 PB33108
38mm			PB3853	PB3863	PB3873	PB3883	PB3893		
43mm		48 PB4348	58 PB4358	68 PB4368	78 PB4378	88 PB4388	98 PB4398		
50mm			53 PB5053	63 PB5063	73 PB5073	83 PB5083	93 PB5093	103 PB50103	
58mm				68 PB5868	78 PB5878	88 PB5888	98 PB5898		
68mm					78 PB6878	88 PB6888	103 PB68103		

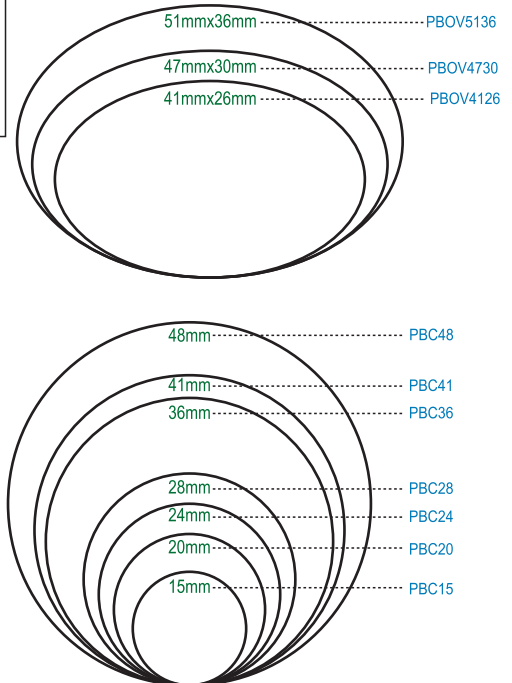



卓達 Trodat-PRINTY

TEXT STAMPS

4907



人名章：
小巧輕便
預設掛繩孔
配底蓋，攜帶方便

人名章

替換印台



單色

6/4907

規格

13mm x 6mm

4908



替換印台



單色

6/4908

規格

15mm x 7mm

4910



替換印台



單色

6/4910

規格

26mm x 9mm

4911

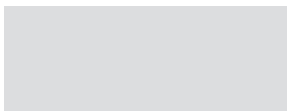

替換印台



單色

6/4911

規格

38mm x 14mm

4912

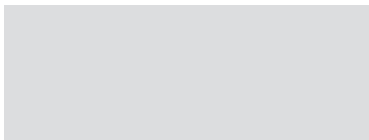

替換印台



單色

6/4912

規格

47mm x 18mm

4913

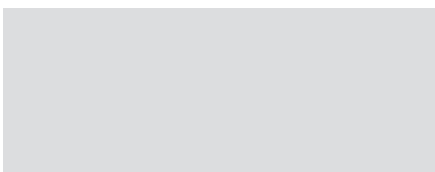

替換印台



單色

6/4913

規格

58mm x 22mm



卓達 Trodat-PRINTY

TEXT STAMPS

4915

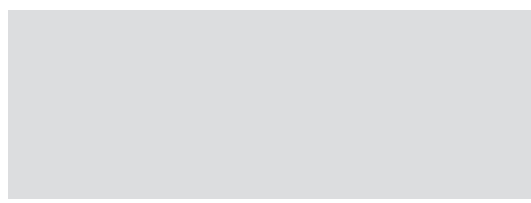

替換印台



單色

6/4915

規格

70mm x 25mm

4918



替換印台



單色

6/4918

規格

75mm x 15mm

4925

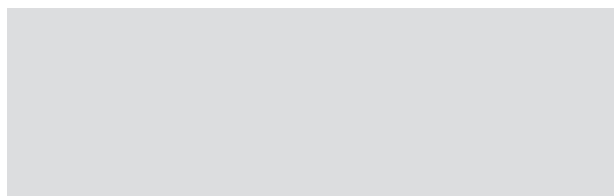

替換印台



單色

6/4925

規格

82mm x 25mm

4926

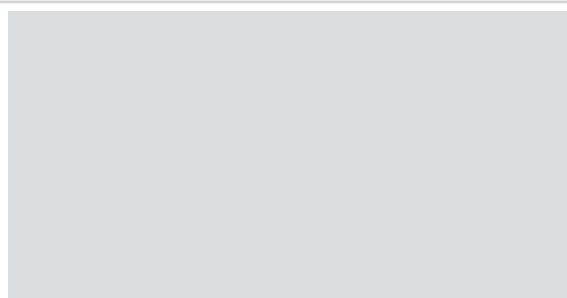

替換印台



單色

6/4926

規格

75mm x 38mm

4927

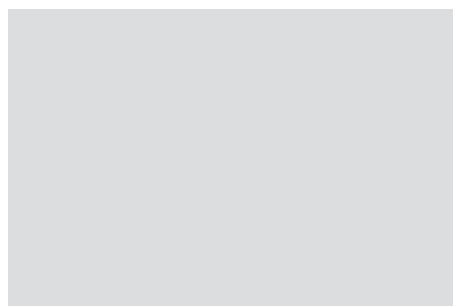

替換印台



單色

6/4927

規格

60mm x 40mm



卓達 Trodat-PRINTY

TEXT STAMPS

4928

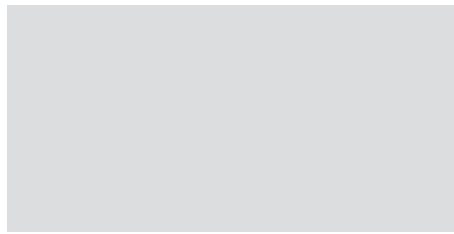

替換印台



單色

6/4928

規格

60mm x 33mm

4929

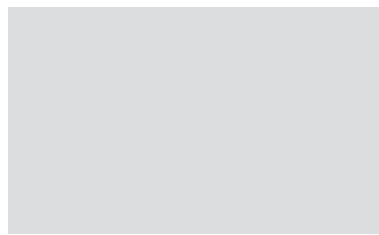

替換印台



單色

6/4929

規格

50mm x 30mm

4931

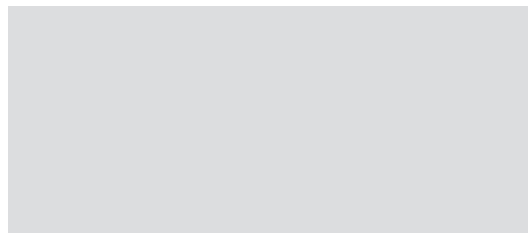

替換印台



單色

6/4931

規格

70mm x 30mm

46019/46025



46019: Ø:19mm



46025: Ø:25mm

替換印台



單色

6/46019
6/46025

規格

46019: Ø:19mm

46025: Ø:25mm

46030/46040

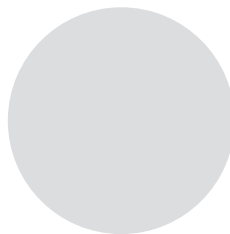

46030: Ø:30mm

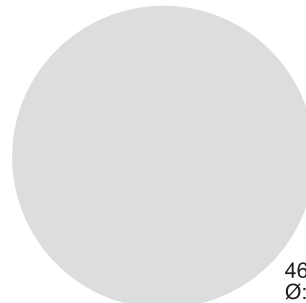

46040:
Ø:40mm

替換印台



單色

6/46030
6/46040

規格

46030: Ø:30mm

46040: Ø:40mm



卓達 Trodat-PRINTY

TEXT STAMPS

46045



46045: Ø:45mm

替換印台



單色

6/46045

規格

46045: Ø:45mm

46050

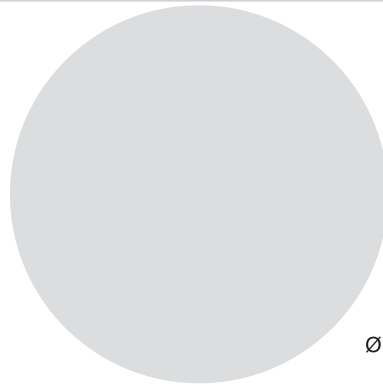

Ø:50mm

替換印台



單色

6/46050

規格

46050: Ø:50mm

44045



替換印台



單色

6/44045

規格

45mm x 30mm

44055



替換印台



單色

6/44055

規格

55mm x 35mm

4916/4917

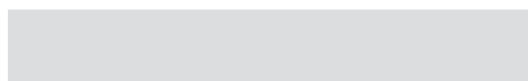

4916: 70mm x 10mm

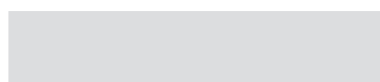

4917: 50mm x 10mm

替換印台



單色

6/4916

6/4917

規格

4916: 70mm x 10mm

4917: 50mm x 10mm



卓達 Trodat-PRINTY

TEXT STAMPS

4941

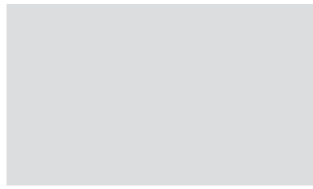

替換印台

單色 6/4941

規格

41mm x 24mm

4921/4922



4921

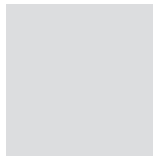

4922

替換印台

單色 6/4921
6/4922

規格

12mm x 12mm
20mm x 20mm

4923

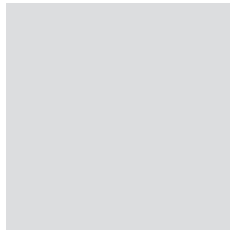

替換印台

單色 6/4923

規格

30mm x 30mm

4924

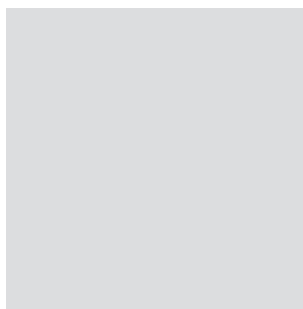

替換印台

單色 6/4924

規格

40mm x 40mm

3911/3912/3913



3911 38mm x 14mm

3912 47mm x 15mm

3913 58mm x 22mm

替換印台

單色 6/3911
6/3912
6/3913

規格

3911:38mm x 14mm
3912:47mm x 15mm
3913:58mm x 22mm



4729



替換印台

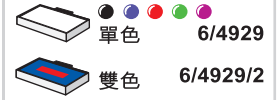

規格

50mm x 30mm
Date size: 3mm

4727



替換印台

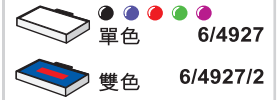

規格

60mm x 40mm
Date size: 4mm

4726



替換印台



規格

75mm x 38mm
Date size: 4mm

4731



替換印台



規格

70mm x 30mm
Date size: 3mm

43132



替換印台

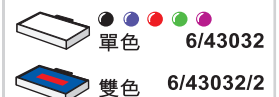

規格

32mm x 32mm
Date size: 3mm



卓達 Trodat-PRINTY

DATE STAMPS + TEXT

46119/46125

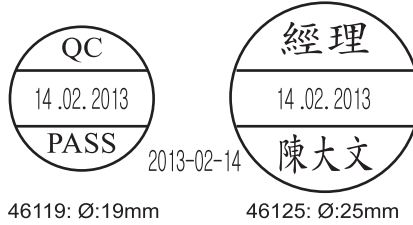

46119: Ø:19mm

46125: Ø:25mm

替換印台



規格

46119: Ø:19mm
46125: Ø:25mm
Date size: 2.8mm

46130/46140

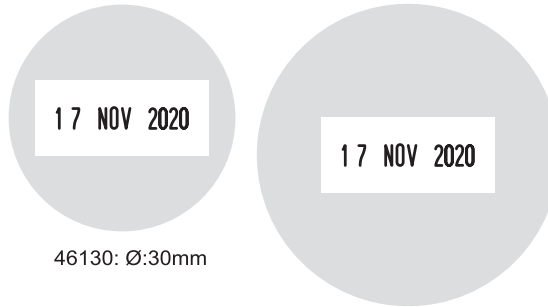

46130: Ø:30mm

46140: Ø:40mm

替換印台

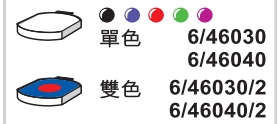

規格

46130: Ø:30mm
46140: Ø:40mm
Date size: 3mm

46145

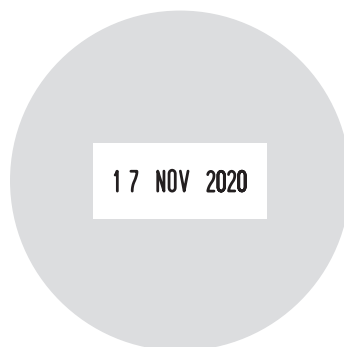

替換印台



規格

Ø:45mm
Date size: 3mm



4724



替換印台

 單色 6/4924

 雙色 6/4924/2

規格

40mm x 40mm
Date size: 3mm

4750



替換印台

 單色 6/4750

 雙色 6/4750/2

規格

41mm x 24mm
Date size: 4mm

4800/4820



17 NOV 2020
4800-Date size: 3mm

17 NOV 2020
4820-Date size: 4mm

替換印台

 單色 6/4911

規格

4800-Date size: 3mm
4820-Date size: 4mm

4810



17 NOV 2020
4810-Mini-Dater
Date size: 3.8mm

替換印台

 單色 6/4910

規格

4810-Mini-Dater
Date size: 3.8mm

4813



替換印台

 單色 6/4817

規格

26mm x 9mm
Date size: 3.8mm

4850



替換印台

 單色 6/4850

規格

25mm x 5mm
Date size: 3.8mm



5200

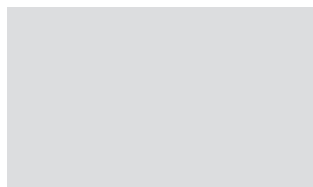

替換印台



單色

6/50

規格

41mm x 24mm

5203

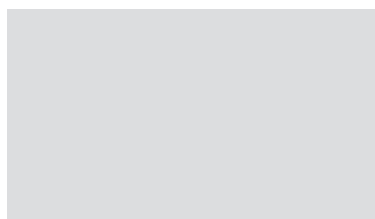

替換印台



單色

6/53

規格

49mm x 28mm

5204

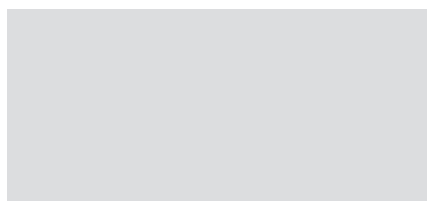

替換印台



單色

6/56

規格

56mm x 26mm

5205

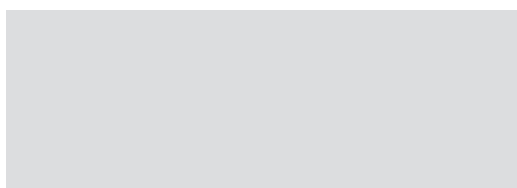

替換印台



單色

6/55

規格

68mm x 24mm

5206

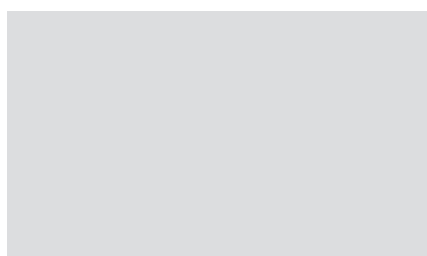

替換印台



單色

6/56

規格

56mm x 33mm



5207

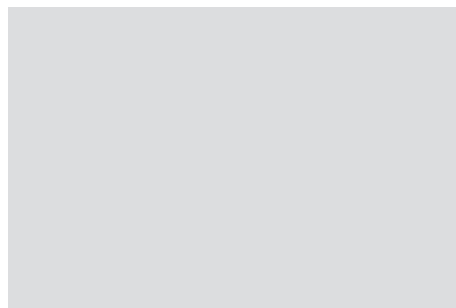

替換印台



單色

6/57

規格

60mm x 40mm

5208

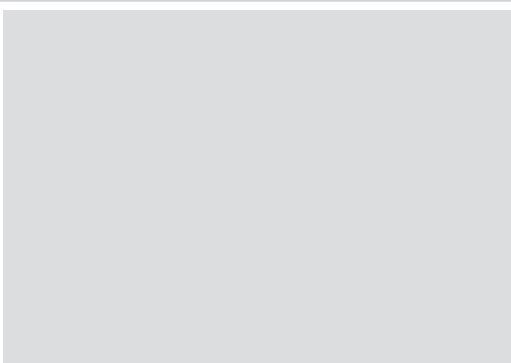

替換印台



單色

6/58

規格

68mm x 47mm

5211

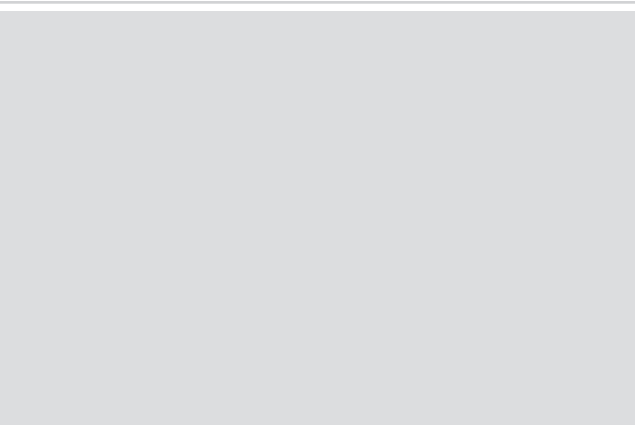

替換印台



單色

6/511

規格

85mm x 55mm

5215



替換印台



單色

6/15

規格

Ø:45mm



DATE STAMPS + TEXT

5430



17 NOV 2020

替換印台

● ● ● ● ● ● 單色 6/50

雙色 6/50/2

規格

41mm x 24mm
Date size: 4mm

5440



17 NOV 2020

替換印台

● ● ● ● ● ● 單色 6/53

雙色 6/53/2

規格

49mm x 28mm
Date size: 4mm

5460



17 NOV 2020

替換印台

● ● ● ● ● ● 單色 6/56

雙色 6/56/2

規格

56mm x 33mm
Date size: 4mm

5470



17 NOV 2020

替換印台

● ● ● ● ● ● 單色 6/57

雙色 6/57/2

規格

60mm x 40mm
Date size: 4mm



5480



替換印台



單色

6/58



雙色

6/58/2

規格

68mm x 47mm

Date size: 4mm

54110



替換印台



單色

6/511



雙色

6/511/2

規格

85mm x 55mm

Date size: 4mm

2910/U1-12, 2910/u1-24

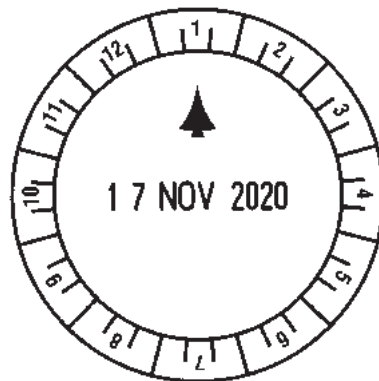

2910/U1-12
Ø:50mm

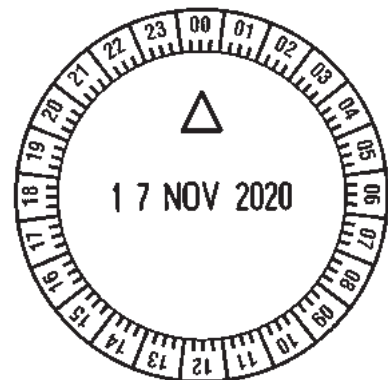

2910/U1-24
Ø:50mm

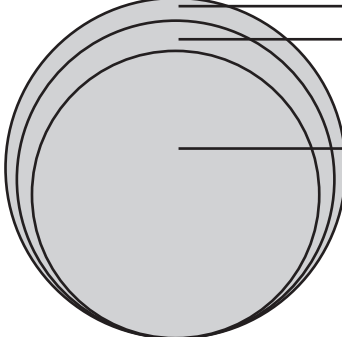

木頭印

	 <p>EC38: Ø:38mm EC42: Ø:42mm EC45: Ø:45mm</p>	<p>規格</p> <p>Max size: EC38: Ø:38mm EC42: Ø:42mm EC45: Ø:45mm</p>
---	---	---

水印-手鉗

		<p>規格</p> <p>Max size: EM38: Ø:38mm</p>
--	---	---

水印-大座

 <p>19.5cm 11.5cm 8.7cm</p>		<p>規格</p> <p>Max size: EM48: Ø:48mm</p>
--	--	---

銅印

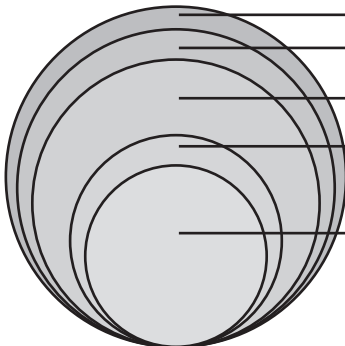
	 <p>EA45: Ø:45mm EA42: Ø:42mm EA38: Ø:38mm EA28: Ø:28mm EA24: Ø:24mm</p>	<p>規格</p> <p>Max size: EA45: Ø:45mm EA42: Ø:42mm EA38: Ø:38mm EA28: Ø:28mm EA24: Ø:24mm</p>
---	---	---

火漆印

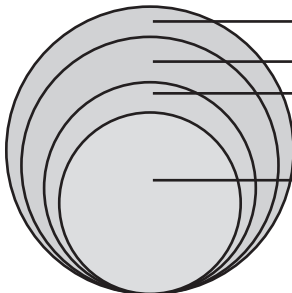
	 <p>EB38: Ø:38mm EB34: Ø:34mm EB30: Ø:30mm EB24: Ø:24mm</p>	<p>規格</p> <p>Max size: EB24: Ø:24mm EB30: Ø:30mm EB34: Ø:34mm EB38: Ø:38mm</p>
--	---	--

私章-白玉

	 <p>爛邊楷書 爛邊隸書 爛邊篆書 圓角行書 直角楷書</p>	<p>顏色 紅色</p> <p>規格</p> <p>Max size: APR12: 11.5mm x 11.5mm APR14: 14.5mm x 14.5mm</p>
---	--	---

私章-黑玉

	 <p>APR16: 16mm x 16mm APR18: 18mm x 18mm APR22: 22mm x 22mm APR24: 24mm x 24mm</p>	<p>顏色 紅色</p> <p>規格</p> <p>Max size: APR16: 16mmx16mm APR18: 18mmx18mm APR22: 22mmx22mm APR24: 24mmx24mm</p>
---	---	---



Company Kit綠盒套裝

BG1

大盒



規格	
公司章程	20本
股書	1本(20張)
大事簿	1本
簽章	1個
21mm圖印	1個
水印	1個

BG3

細盒



規格	
公司章程	10本
股書	10張
簽章	1個
21mm圖印	1個
水印	1個

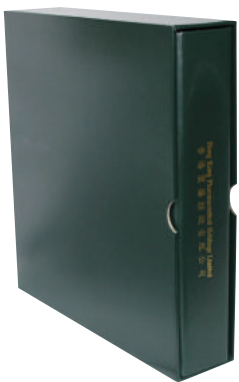



KA100	REVISED	KA107	CONFIRMATION	KA114	CERTIFIED BY _____	KA121	PAID
KA101	AMENDMENT	KA108	CONFIDENTIAL	KA115	CHECKED DATE/BY _____	KA122	PAID
KA102	APPROVED	KA109	OVER DUE	KA116	RECEIVED DATE _____	KA123	FAX OUT
KA103	CERTIFIED TRUE COPY	KA110	A/C PAYEE ONLY	KA117	COMPLETED BY _____ DATE _____	KA124	FAX IN
KA104	COPY	KA111	URGENT	KA118	APPROVED	KA125	REFAX
KA105	C.O.D.	KA112	DRAFT	KA119	COMPLETED	KA126	FAXED
KA106	VOID	KA113	SAMPLE	KA120	ORIGINAL	KA127	MAILED

KA201	修正 AMENDMENT	KA209	現金 CASH	KA301	貨銀兩訖	KA309	急件
KA202	速遞 BY COURIER	KA210	貨到付款 C. O. D.	KA302	批准付訖	KA310	特價
KA203	作廢 CANCELLED	KA211	現沽單 CASH SALE	KA303	現金收訖	KA311	附件
KA204	完成 COMPLETED	KA212	裝箱單 PACKING LIST	KA304	現金付訖	KA312	密件
KA205	副本 COPY	KA213	印刷品 PRINTED MATTER	KA305	轉賬付訖	KA313	樣本
KA206	正本 ORIGINAL	KA214	急件 URGENT	KA306	貨到付款	KA314	正本
KA207	發票 INVOICE	KA215	樣本 SAMPLE	KA307	現金 作廢	KA315	副本
KA208	送貨單 DELIVERY NOTE	KA216	批准 APPROVED	KA308		KA316	核銷



細明體(繁簡)	C1	天地玄黃宇宙洪荒日月盈昃辰宿列張寒來暑往秋收冬藏
粗明體	C2	天地玄黃宇宙洪荒日月盈昃辰宿列張寒來暑往秋收冬藏
細黑體	C4	天地玄黃宇宙洪荒日月盈昃辰宿列張寒來暑往秋收冬藏
粗黑體	C5	天地玄黃宇宙洪荒日月盈昃辰宿列張寒來暑往秋收冬藏
細圓體	C7	天地玄黃宇宙洪荒日月盈昃辰宿列張寒來暑往秋收冬藏
粗圓體	C8	天地玄黃宇宙洪荒日月盈昃辰宿列張寒來暑往秋收冬藏
新篆體	C11	天地玄黃宇宙洪荒日月盈昃辰宿列張寒來暑往秋收冬藏
古印體	C12	天地玄黃宇宙洪荒日月盈昃辰宿列張寒來暑往秋收冬藏
布丁體	C13	天地玄黃宇宙洪荒日月盈昃辰宿列張寒來暑往秋收冬藏
仿宋體W6P	C14	天地玄黃宇宙洪荒日月盈昃辰宿列張寒來暑往秋收冬藏
行書體	C15	天地玄黃宇宙洪荒日月盈昃辰宿列張寒來暑往秋收冬藏
娃娃體	C16	天地玄黃宇宙洪荒日月盈昃辰宿列張寒來暑往秋收冬藏
海報體	C18	天地玄黃宇宙洪荒日月盈昃辰宿列張寒來暑往秋收冬藏
彩帶體	C19	天地玄黃宇宙洪荒日月盈昃辰宿列張寒來暑往秋收冬藏
墨字體	C22	天地玄黃宇宙洪荒日月盈昃辰宿列張寒來暑往秋收冬藏
龍門石碑	C23	天地玄黃宇宙洪荒日月盈昃辰宿列張寒來暑往秋收冬藏
魏碑體(繁簡)	C24	天地玄黃宇宙洪荒日月盈昃辰宿列張寒來暑往秋收冬藏
少女體WP5	C25	天地玄黃宇宙洪荒日月盈昃辰宿列張寒來暑往秋收冬藏
楷書體W5(繁簡)	C26	天地玄黃宇宙洪荒日月盈昃辰宿列張寒來暑往秋收冬藏
楷書體W7	C27	天地玄黃宇宙洪荒日月盈昃辰宿列張寒來暑往秋收冬藏
POPI體W5	C28	天地玄黃宇宙洪荒日月盈昃辰宿列張寒來暑往秋收冬藏
勘亭流	C30	天地玄黃宇宙洪荒日月盈昃辰宿列張寒來暑往秋收冬藏
棣書體W5	C31	天地玄黃宇宙洪荒日月盈昃辰宿列張寒來暑往秋收冬藏

國 國 國 國 國 國 國 國 國 國 國 國 國 國 國 國
 Point 8 9 10 12 14 16 18 20 22 24 26 28 30

M M M M M M M M M M M M M M M M
 Point 8 9 10 12 14 16 18 20 22 24 26 28 30

Chan Tai Man 12pt Time
 陳大文 4號字
 陳大文 3號4位
 陳大文 2號4位

Time New Roman	E1	ABCDEFGHIJKLMNOPQRSTUVWXYZ abcdefghijklmnopqrstuvwxyz
	E2	ABCDEFGHIJKLMNOPQRSTUVWXYZ abcdefghijklmnopqrstuvwxyz
Arial	E5	ABCDEFGHIJKLMNOPQRSTUVWXYZ abcdefghijklmnopqrstuvwxyz
	E6	ABCDEFGHIJKLMNOPQRSTUVWXYZ abcdefghijklmnopqrstuvwxyz
Hobo	E25	ABCDEFGHIJKLMNOPQRSTUVWXYZ abcdefghijklmnopqrstuvwxyz
Allgero BT	E26	ABCDEFGHIJKLMNOPQRSTUVWXYZ abcdefghijklmnopqrstuvwxyz
Ariston	E27	<i>ABCDEFGHIJKLMNOPQRSTUVWXYZ abcdefghijklmnopqrstuvwxyz</i>
Bremen Bd BT	E28	ABCDEFGHIJKLMNOPQRSTUVWXYZ 此款沒有小楷
Brush Script	E29	<i>ABCDEFGHIJKLMNOPQRSTUVWXYZ abcdefghijklmnopqrstuvwxyz</i>
Brush Hand	E30	ABCDEFGHIJKLMNOPQRSTUVWXYZ abcdefghijklmnopqrstuvwxyz
CommercialScript	E31	<i>ABCDEFGHIJKLMNOPQRSTUVWXYZ abcdefghijklmnopqrstuvwxyz</i>
English111 Presto	E32	<i>ABCDEFGHIJKLMNOPQRSTUVWXYZ abcdefghijklmnopqrstuvwxyz</i>
Linotext-Light	E34	<i>ABCDEFGHIJKLMNOPQRSTUVWXYZ abcdefghijklmnopqrstuvwxyz</i>
Park Avenue	E35	<i>ABCDEFGHIJKLMNOPQRSTUVWXYZ abcdefghijklmnopqrstuvwxyz</i>
RondoScript	E36	<i>ABCDEFGHIJKLMNOPQRSTUVWXYZ abcdefghijklmnopqrstuvwxyz</i>
Diskus	E37	<i>ABCDEFGHIJKLMNOPQRSTUVWXYZ abcdefghijklmnopqrstuvwxyz</i>
Staccato222 BT	E38	ABCDEFGHIJKLMNOPQRSTUVWXYZ abcdefghijklmnopqrstuvwxyz
ZapfChancery-Me	E39	<i>ABCDEFGHIJKLMNOPQRSTUVWXYZ abcdefghijklmnopqrstuvwxyz</i>
Isadora Regular	E40	<i>ABCDEFGHIJKLMNOPQRSTUVWXYZ abcdefghijklmnopqrstuvwxyz</i>
Copperplate	E42	ABCDEFGHIJKLMNOPQRSTUVWXYZ 此款沒有小楷
Cookie	E43	ABCDEFGHIJKLMNOPQRSTUVWXYZ abcdefghijklmnopqrstuvwxyz
Koala	E45	<i>ABCDEFGHIJKLMNOPQRSTUVWXYZ abcdefghijklmnopqrstuvwxyz</i>
Amelia BT	E46	ABCDEFGHIJKLMNOPQRSTUVWXYZ abcdefghijklmnopqrstuvwxyz